

MANUFACTURER'S MANUAL

MPC6515

V 2.0

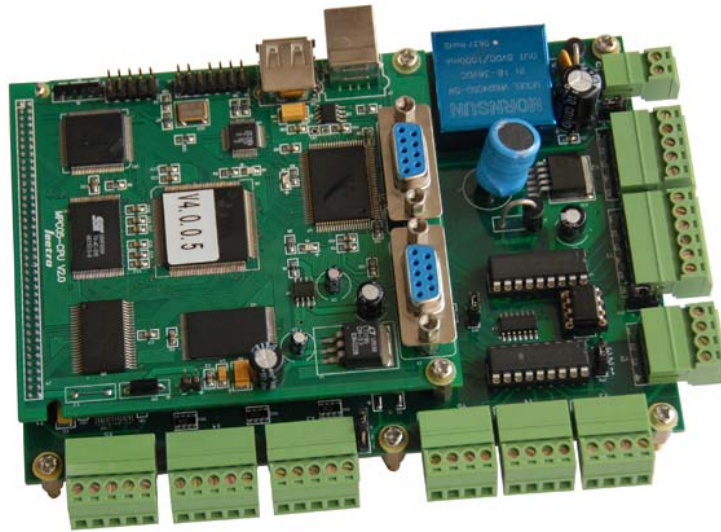

Step-Servo Co., Ltd.
Building 8-B
Dayi Zone of Incubating Hi-Tech
No.1 South 2nd Keyuan Rd
Chengdu 610041
CHINA
www.leetro.com

Copyright

The content of this manual has been carefully prepared and is believed to be accurate, but no responsibility is assumed for inaccuracies.

Step-Servo Co., Ltd. reserves the right to make changes without further notice to any products herein to improve reliability, function or design. Step-Servo Co., Ltd. does not assume any liability arising out of the application or use of any product or circuit described herein; neither does it convey any license under its patent rights of others. Step-Servo and Leetro™ are trademarks of Step-Servo Co., Ltd.

Step-Servo Co., Ltd.'s general policy does not recommend the use of its products in life support or aircraft applications wherein a failure or malfunction of the product may directly threaten life or injury. Per Step-Servo Co., Ltd.'s terms and conditions of sales, the user of Step-Servo Co., Ltd. products in life support or aircraft applications assumes all risks of such use and indemnifies Step-Servo Co., Ltd. against all damages.

Step-Servo Co., Ltd.

Customers outside China, please email to: overseas@step-servo.com

©2005 by Step-Servo Co., Ltd. All Rights Reserved

Table of Content

CHAPTER 1 PREFACE.....	1
CHAPTER 2 OVERVIEW	2
2.1 MPC6515 INTRODUCTION	2
2.2 CONTROL SYSTEM CONFIGURATION	2
2.3 MPC6515 PACK LIST.....	3
CHAPTER 3 INTALLATION.....	4
3.1 MAINBOARD	4
3.2 PAD03	5
CHAPTER 4 MPC6515 HARDWARE INTERFACES	6
4.1 MPC6515/CPU INTERFACES	6
4.2 MPC6515/MC V2.0 INTERFACES	8
CHAPTER 5 PAD03 OPERATION.....	11
5.1 CONNECTION	11
5.2 START SYSTEM.....	12
5.3 MAIN INTERFACE	12
5.4 SUPPORTING INTERFACE	15
<i>Cutting Contour.....</i>	<i>15</i>
<i>Laser Set.....</i>	<i>15</i>
<i>Jog Set.....</i>	<i>16</i>
<i>Language Options.....</i>	<i>17</i>
5.5 PROCESS	17
5.6 DOWNLOAD WITH USB FLASH DISK.....	19
CHAPTER 6 HMI DEVELOPMENT	20
6.1 PROTOCOL AND SYSTEM SETTING	20
6.2 ADDRESS.....	20
6.3 SAMPLE PROGRAM.....	24
CHAPTER 7 DOWNLOAD DOCUMENT.....	25
7.1 UPDATE FIRMWARE.....	25
7.2 DOWNLOAD DATA.....	26
CHAPTER 8 ERROR CODE.....	27
8.1 INDICATOR LIGHT DESCRIPTION.....	27
8.2 ERROR CODE DESCRIPTION.....	27
CHAPTER 9 FAQ	31
9.1 EXTERNAL INDICATOR LIGHT OF U DISK	31
<i>Functionality.....</i>	<i>31</i>
<i>Instruction.....</i>	<i>31</i>

9.2	CUSTOMIZE PAD03 CONTROL PANEL	31
	<i>Functionality</i>	31
9.3	EXTERNAL INDICATOR LIGHT OF PROCESSING STATUS.....	32
	<i>Functionality</i>	32
	<i>Instruction</i>	32
9.4	BLOW-OFF.....	32
	<i>Functionality</i>	32
	<i>Instruction</i>	32
9.5	GRADE ENGRAVE	33
	<i>Functionality</i>	33
	<i>Instruction</i>	33
9.6	SOFTWARE LIMIT UNDER IMMEDIATE MODE	33
	<i>Functionality</i>	33
	<i>Instruction</i>	33
9.7	CONTROL TWO LASER HEADS	33
	<i>Functionality</i>	33
	<i>Instruction</i>	33

Chapter 1 Preface

Thank you for using Step-Servo's Leetro™ motion controllers. MPC6515, specially designed for laser engraving and cutting system.

This manual will instruct you on using MPC6515 in details.

Please read the instructions carefully before using MPC6515.

	User should debug the system with full consideration on protection measures to avoid any machine damage or human injury
Warning	

	Do not connect or use the Products without understanding this manual.
Prohibited	

	Do not disassemble, modify nor repair the Products without being authorized.
Prohibited	

	Do not subject the Product to water, corrosive or flammable gases, and combustibles.
Prohibited	

Chapter 2 Overview

2.1 MPC6515 Introduction

The MPC6515 controller is a stand-alone control card specially designed for the control system of laser engraving and cutting machines. User can edit graphics, set parameters, and optimize path to develop a process file using computer.

If you want to use DSP5.0 to control the motion, please connect MPC6515 to PC using the USB connect cable in the pack.

2.2 Control System Configuration

Please see the following diagram on MPC6515 motion control system:

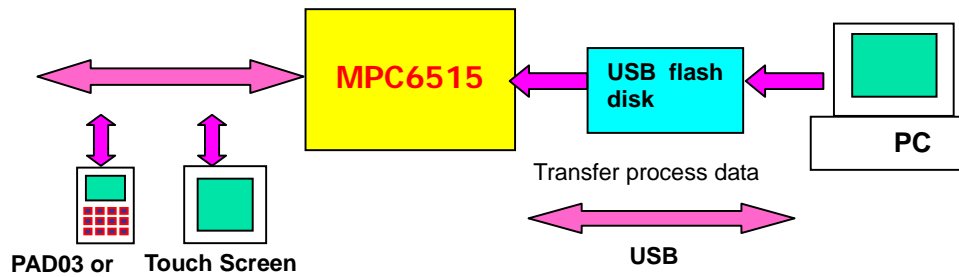

2.3 MPC6515 Pack List

No.	ITEM	QTY	Description	Type	Remark
1	MPC6515 Control Card	1		Standard	
2	256M USB Flash Disk	1	Used to upgrade firmware and download data to MPC6515/CPU	Standard	
3	USB-AA-1.5M	1	Connect cable of USB flash disk (Length:1.5M)	Standard	
4	USB-AB-3M	1	Used to connect PC to MPC6515/CPU (Length: 3M)	Standard	
5	C4-PAD03-1.5M	1	Used to connect PAD03 to MPC6515/CPU	Standard	
6	PAD03-E	1	Human-Machine Interface	Standard	
7	USB Softdog(Red)	1	Key of control software Lasercut5.0. To make installed Lasercut5.0 active to use, please insert softdog to the USB interface of PC	Standard	
8	Software CD	1	Lasercut5.0, MPC6515 driver	Standard	

Chapter 3 Intallation

3.1 Mainboard

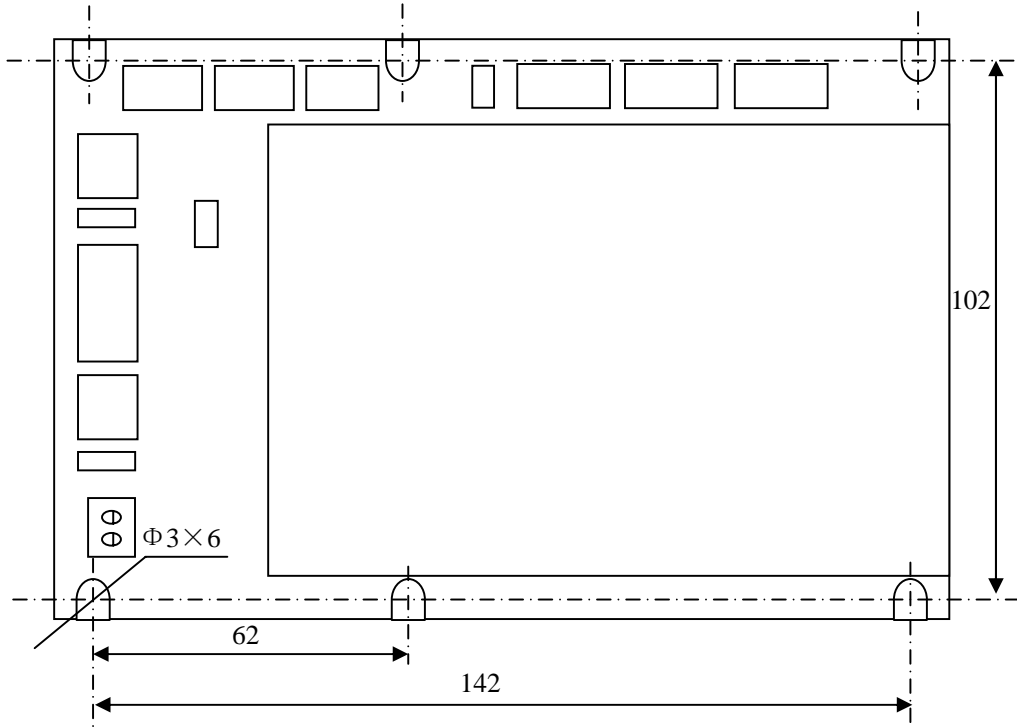

The mainboard adopts 6 bolts of M3

3.2 PAD03

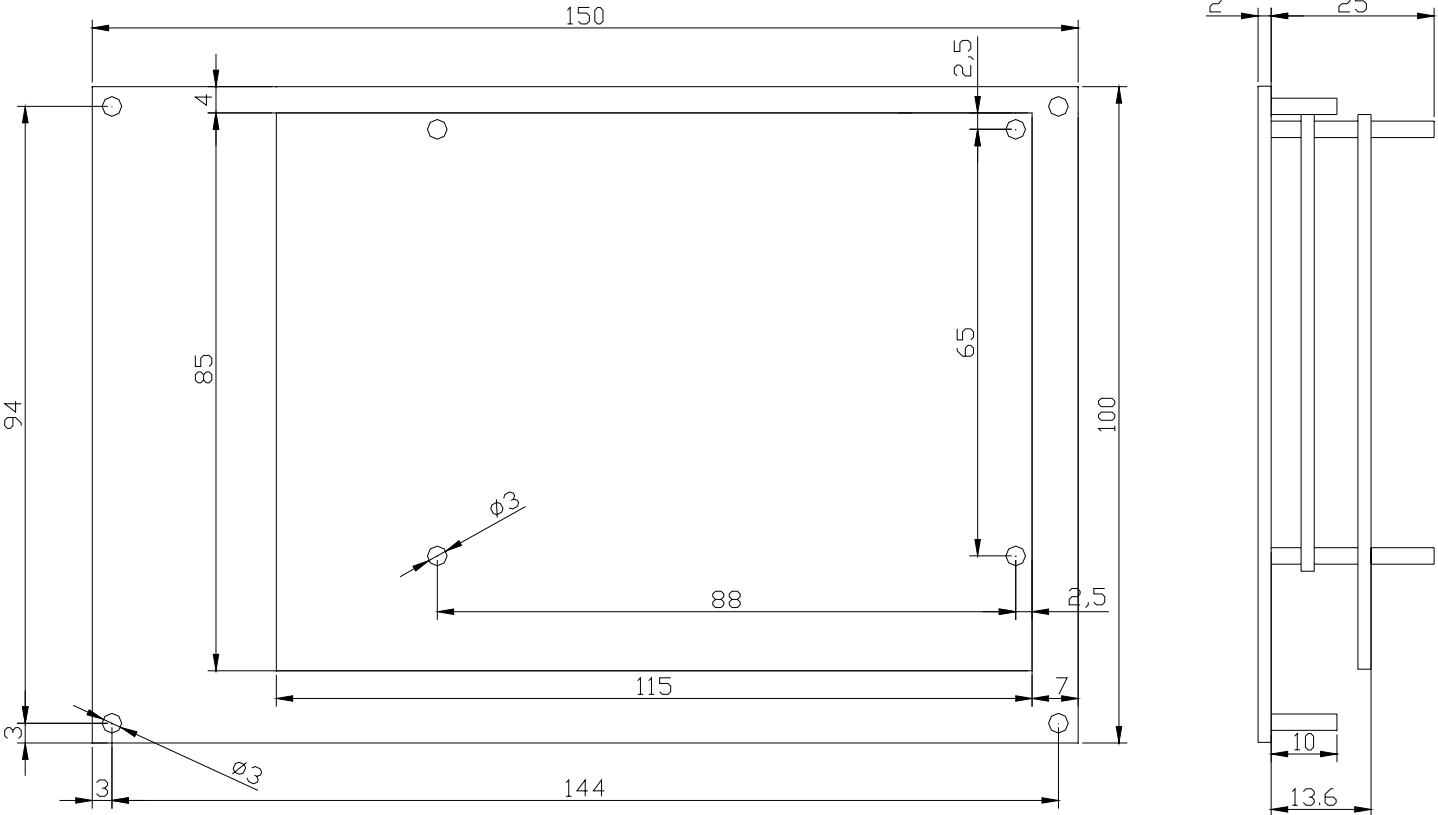

Chapter 4 MPC6515 Hardware Interfaces

MPC6515 controller is composed of two parts:

- 1) MPC6515/MC motion control daughter board
- 2) MPC6515/CPU CPU mainboard

User can find corresponding mark on each board

4.1 MPC6515/CPU Interfaces

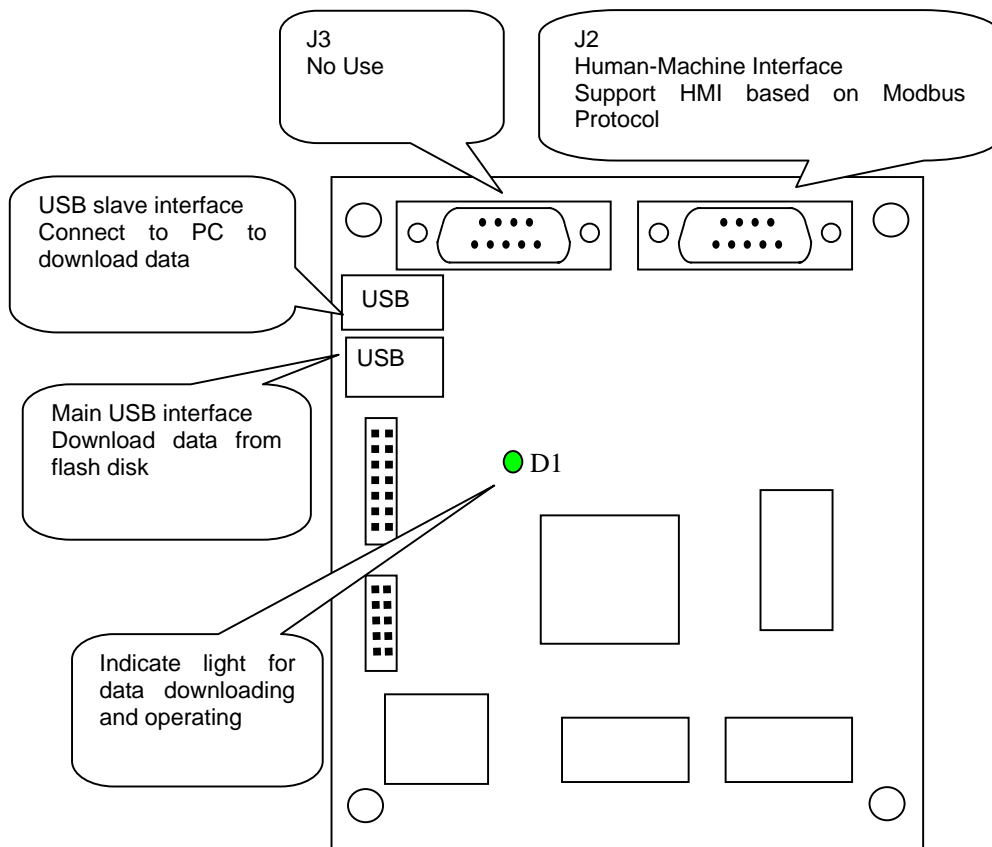

J2: HMI (RS232) -support HMIs such as EasyView, BYDseries HMI, PAD03, etc. based on Modbus Protocol

J2 adopts DB9-pin plug. Pin2, Pin3, Pin5 and Pin9 are used.

Pins	1	2	3	4	5	6	7	8	9
Description		TXD	RXD		GND				+5V

- Wiring of J2 and EasyView RS232 (PLC):

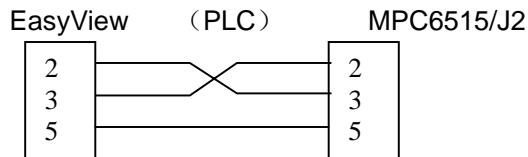

- Wiring of J2 and PAD03 RS232:

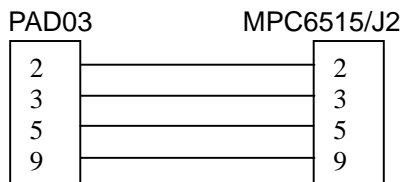

- Wiring of J2 and BYDseries HMI RS232 (PLC):

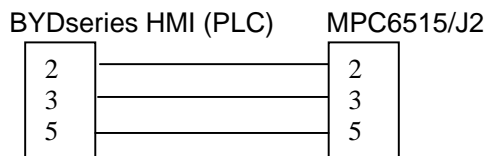

4.2 MPC6515/MC V2.0 Interfaces

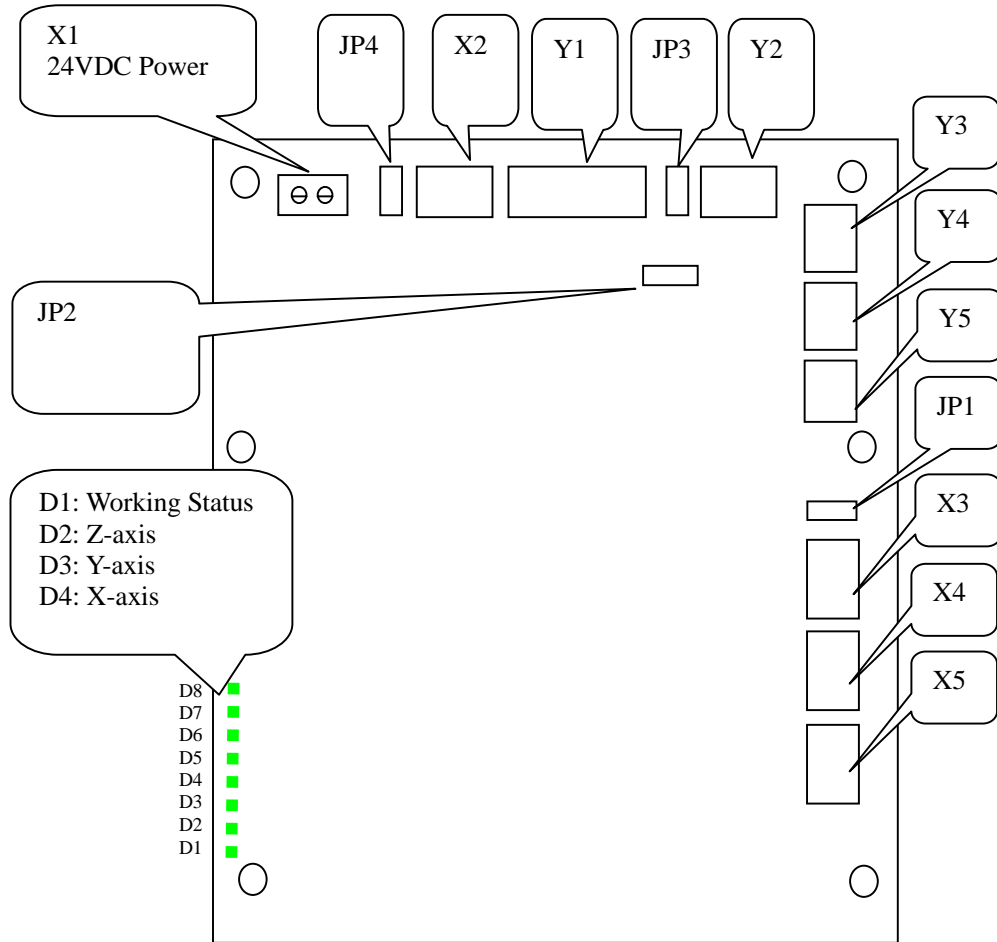

	<p>Please pay attention to the version of MPC6515/MC. If the version of circuit board is V1.0, user cannot find version number in the circuit board.</p>
<p>Caution</p>	

	Pin Array					
	1	2	3	4	5	6
X1	24V	24V GND				
X2	Foot Switch	Uncapping protection	Reserve	5V/24V GND	5V/24V	
X3	Z-axis Forward Limit	Z-axis Reverse Limit	Z-axis Origin	5V/24V GND	5V/24V	
X4	Y-axis Forward Limit	Y-axis Reverse Limit	Y-axis Origin	5V/24V GND	5V/24V	
X5	X-axis Forward Limit	X-axis Reverse Limit	X-axis Origin	5V/24V GND	5V/24V	
Y1	Blow-off	Processing Finished	USB Flash Disk Indication	Reserve	5V/24V GND	5V/24V
Y2	Laser Power GND	Analog Output	Laser Power	Laser On/Off		
Y3	Z-axis Pulse	Z-axis Direction	5V GND	5V		
Y4	Y-axis Pulse	Y-axis Direction	5V GND	5V		
Y5	X-axis Pulse	X-axis Direction	5V GND	5V		

X1: Input power interface (24VDC)

Note: MPC6515 adopts single 24VDC power supply. The other power pins are output

	MPC6515 adopts single 24VDC. User must use proper and reliable power supply. Exorbitant voltage could result in damage of components, while low voltage could result in problem in operation.
Warning	

power of the controller.

	The output power of the above pins should be used only for the common-anode and common-cathode of control signals, and should not be used as the power supply for motor drives. Failure to observe this instruction could result in damage of the controller
Prohibited	

JP1:

Note: JP1 is related with X3, X4 and X5. If 24V voltage is required for input signal ports X3, X4 and X5, the jumper should be connected to Pin1 and Pin2. If 5V voltage is required, the jumper should be connected to Pin2 and Pin3. If the jumper is removed, Pin5 of X3, X4 and X5 not connected.

JP2:

Note: JP2 is related with Y2. For analog-control laser power, remove the jumper,connect laser power to Pin2. For PWM-control laser power, connect the power to Pin3.

JP3:

Note: JP3 is related with Y1. If output Y1 to drive a 24V relay, the jumper should be connected to Pin1 and Pin2. To drive a 5V relay, the jumper should be connected to Pin2 and Pin3. If the jumper is removed, Pin6 of Y1 not connected.

JP4:

Note: JP4 is related with X2. If 24V is required for the general input X2, the jumper should be connected to Pin1 and Pin2. If 5V voltage is required, the jumper should be connected to Pin2 and Pin3. If the jumper is removed, Pin5 of X2 not connected.

	Pin 3 and Pin4 of Y3, Y4, and Y5 is output 5V power of MPC6515, can be the common anode for motor drive. Do not connect external 5V to Pin3 and Pin4.
Warning	

	All inputs and outputs are single-ended
Caution	

	GND of laser power should be connected to Pin1 of Y2, Common-ground.
Caution	

Chapter 5 PAD03 Operation

5.1 Connection

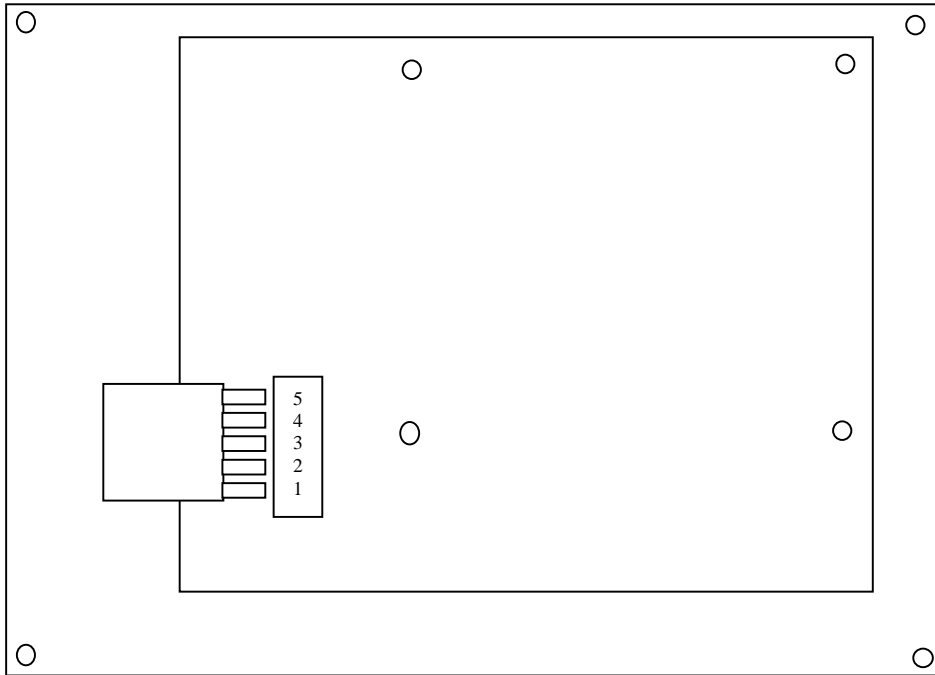

- Connect MPC6515/J2 to PAD03 RS232:

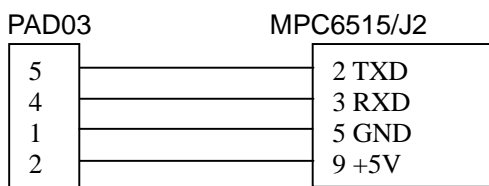

5.2 Start System

When system started, it is displayed as follows:

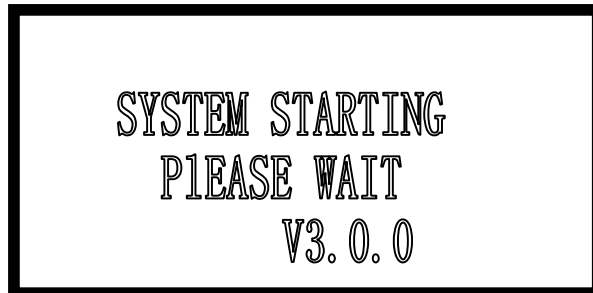

V3.0.0 is the version number of PAD.

5.3 Main Interface

If there's no communication problem with MPC6515, main interface will be shown as follows:

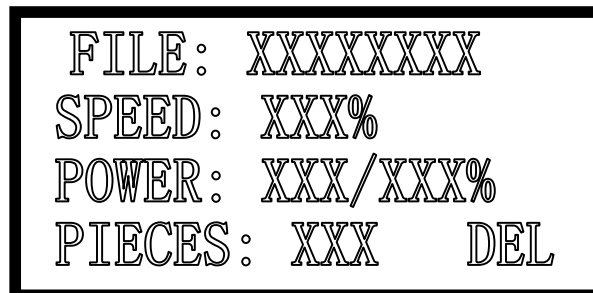

User can set parameters according to the following parameter descriptions:

File: processing file name



Speed: percentage of the processing speed



Power: percentage of processing power. The first one is the power corresponding to low speed, while the latter one is the power corresponding to high speed.

Pieces: repeat times of a processing file



Cursor appears at this time

Then

Press “” “” to move the cursor to select the option you want to modify;

Press “” “” to set the values of selected option, including processing speed,

power corresponding to low speed, power corresponding to high speed and pieces, stepping=1;

Press “” “” select a file. If there's no file in controller, no name of file will be shown.

To delete a file: Press DEL → Enter

To process a file: Press “Start/Pause”





Note:





User should press “” to confirm the settings on speed, power and pieces.

By using “” to confirm the settings, these parameters will not be lost even the power goes off.

Press “Esc”, cursor will disappear

Then

Press “” “” “” “” to move the laser head.

For point-to-point beaming, hold down “Shoot”  button, and Press  “” “” “ ”

Press “Shoot” to beam according to the settings of Shooting;

Press “Reset”, then X-axis and Y-axis make homing motion simultaneously;

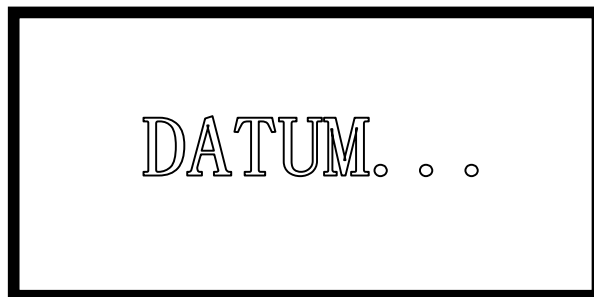

X and Y axes will not stop until they reach their origin point respectively or until the user press “ Stop” to stop the motion.

Press "Test" to make contouring motion:



Press "←" to return to the main interface

Jogging and reset of Z-axis

Press button "Z", interface displays as follows



Press "↑" "↓" to start Z-axis jogging;

Press "Reset" to start Z-axis homing motion.

Press "Stop" to stop Z-axis homing motion;

Other buttons will not work at this time.

Press "Z" to return to the main interface;

When Z-axis is making homing motion, interface displays as follows:



This motion will not stop until Z-axis reaches the origin, or until user press "Stop ". Then

the display will return to Z-Axis Operate

5.4 Supporting Interface

Press "Menu" to enter the supporting interface, which displays as follows:

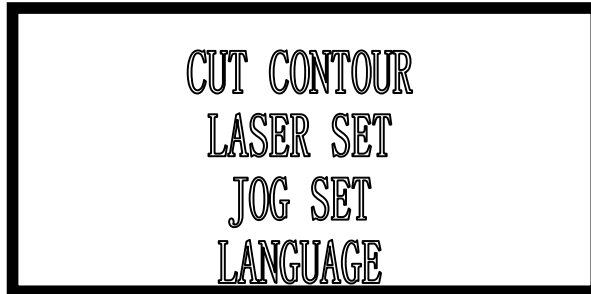

Cursor can be seen

Press "←" "→" move the cursor

Press "↵" to confirm

Press "Esc" to return to main interface

Cutting Contour

To cut contour, select the corresponding option by cursor and press "↵":



During the motion, all buttons cannot work

It will return to the main interface once the motion completed

Laser Set

To start shooting, select the corresponding option by cursor and press "↵":

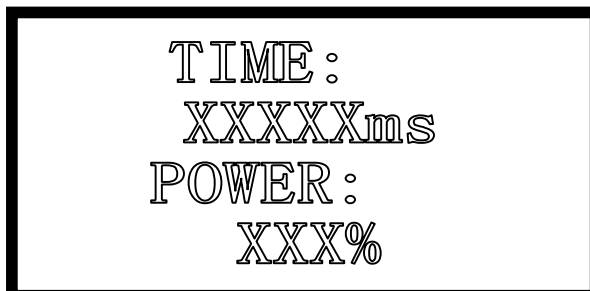

The default value of time is 0 ms, default power value is 100%;

Press “ ← ” “ → ” move the cursor to choose Time or Power;

Press “ ↑ ” “ ↓ ” set parameters, setting=1;

Time ranged from 0-99999ms, Power ranged from 0-100%. Press “ ↵ ” “ ” to make the settings effective.

Press “Esc” to return to supporting interface

If the time=0, laser will be on immediately upon pressing the button “Shoot”, and be off when stop pressing. If time is set to be a fixed value, laser will be on and off for each press. Unit for the time is ms.

Jog Set

To start Jogging, select the corresponding option by cursor and press “ ”:

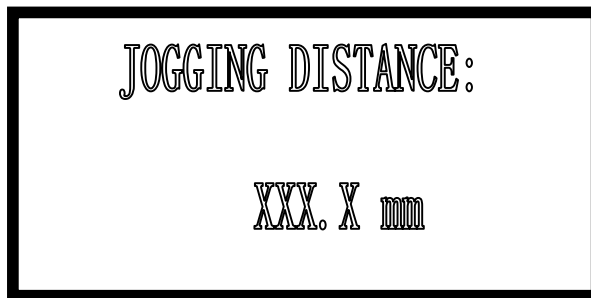

Press “ ↑ ” “ ↓ ” to set parameters. Press “ ↵ ” to confirm. Press “Esc” to return to supporting interface.

Then press “ ↑ ” “ ↓ ” “ ← ” “ → ” move the laser head. Distance of Jogging is in accordance with the settings.



The default value =0, start moving upon pressing the button “Shoot”, and stop when stop pressing. If hold down the button, keep continuous motion at low speed for 2 seconds and high speed for 2 seconds. If the value is not 0, laser head start moving a fixed distance at high speed. Low speed and high speed correspond respectively to the low speed and high speed set in machine options.

By using “ ↵ ” to confirm the settings, these parameters will not be lost even the power goes off.

Language Options

Move cursor to Language and press  to choose a language:



Press  " "  move cursor, press "  choose a preferred display language

If without pressing button to set a language, system will choose the language where the cursor is and return to the supporting interface automatically in 30 seconds.

5.5 Process

Return to main interface, press "Start/Pause" to start the processing:

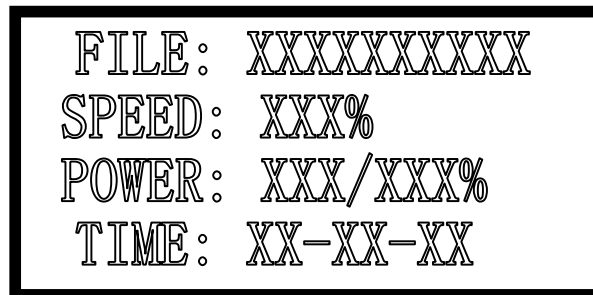

Parameter descriptions are as follows:

File: processing file name

Speed: percentage of the processing speed

Power: percentage of processing power. The first one is the power corresponding to low speed, while the latter one is the power corresponding to high speed.

Time: processing time spent

During the process, only following buttons can work-- "Start/Pause", "Stop", "Up", "Down", "Left", "Right";

Buttons “Up” and “Down” are used to set the processing speed. Stepping=1. The value ranged from 0-100;

Buttons “Left” and “Right” are used to set the power corresponding to high speed. Stepping=1. The value ranged from 0-100;

Press “Start/Pause” for odd times, it will enter pause interface and show as follows:

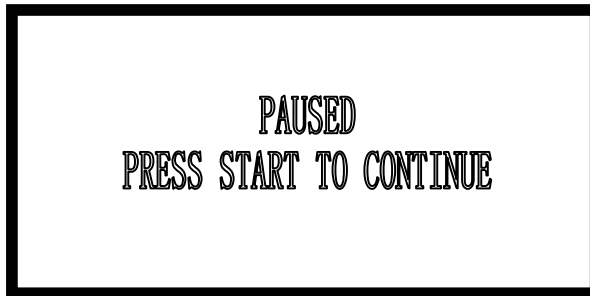

In this interface, only “Start/Pause” and “Stop” buttons can work;

Press “Start/Pause” for even times during processing, it will return from pause interface to process interface.

Press “Stop ” during the process, it will stop and show as follows:

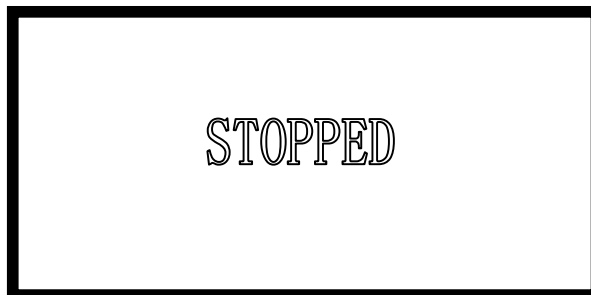

In this interface, only “Start/Pause”, “Esc”, “Up”, “Down”, “Left” and “Right” buttons can work.

Press “Start/pause” to enter process interface;

Press “Esc” to enter main interface;

Press “Up”, “Down”, “Left” and “Right” buttons to make jogging motion according to the set parameters.

When processing completes, only “Start/Pause” and “Esc” buttons can work.

Press “Start/Pause” to enter the processing interface;

Press “Esc” to return to main interface.

5.6 Download with USB Flash Disk

When a USB flash disk is plugged into the controller, main interface will show as follows:



Controller starts downloading the process files once the USB flash disk is detected.

Interface displays as follows:

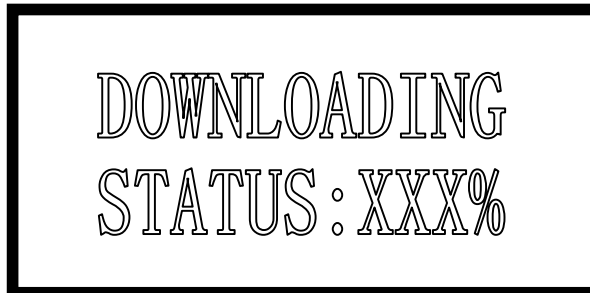

Once the downloading completes, the Buzzer starts ringing, and the interface displays as follows:



Remove the USB flash disk, and the Buzzer will cease from ringing.

	USB flash disk should be formatted to FAT16, if fail to follow this instruction, the flash disk cannot be detected by the controller
Caution	

Chapter 6 HMI Development

All HMI support Modbus Protocol can be developed to control panel of MPC6515. Take MT506LV45WV as an example:

6.1 Protocol and System Setting

Standard Modbus Protocol

PLC Type: Modbus RTU

Baud rate: 9600bps

Data bit: 8-bit;

Stop bit: 1-bit;

Verify: None.

6.2 Address

- Address and function descriptions of PLC relay shown as follows:

Components			Function	Type	Remarks
Address		Properties			
1	0x	ON	Start/Pause	Button	
2	0x	ON/OFF switch	Pause	Button	
3	0x	ON	Resume	Button	
4	0x	ON	Stop	Button	
5	0x	ON/OFF	Up	Button	
6	0x	ON/OFF	Down	Button	
7	0x	ON/OFF	Left	Button	
8	0x	ON/OFF	Right	Button	
9~11	0x		Reserve		
12	0x	ON	Z-axis restoration	Button	
13	0x	ON	XY axes restoration	Button	
14	0x	ON	Speed+1 during processing	Button	
15	0x	ON	Speed-1 during processing	Button	
16	0x	ON	High Speed Power +1 during processing	Button	
17	0x	ON	High Speed Power-1 during processing	Button	
18	0x	ON	Contouring	Button	
19	0x	ON	Cut contour	Button	
20	0x	ON/OFF	Shoot	Button	
21	0x	ON/OFF	Z-axis jogs in positive direction	Button	
22	0x	ON/OFF	Z-axis jogs in negative direction	Button	
30	0x	ON	Delete the file	Button	
31	0x	ON	Go to the next file	Button	
32	0x	ON	Go to the previous file	Button	
33	0x		Status: 1= in processing; 0= process finished	Status	

- Address and function descriptions of PLC register shown as follows:

Address	Components	Data Type	Data length		Function	
			bit	byte		
1	4x	BIN	16	1	Percentage of processing speed (%)	
2	4x	BIN	16	1	Laser power corresponding to high speed	
3	4x	BIN	16	1	Laser power corresponding to low speed	
4	4x	BIN	16	1	Set the pieces to be processed	
5	4x	BIN	16	1	Reserve	
6	4x	BIN	16	1	Pieces has been processed	
7	4x	BIN	16	1	Reserve	
8	4x	BIN	32	2	Shooting time:low 16 bit	Shooting time. Unit: mm
9					Shooting time:high 16 bit	
10	4x	BIN	16	1	Jogging distance	
11	4x	BIN	16	1	Reserve	
12	4x	BIN	16	1	Reserve	
13	4x	BIN	16	1	Shooting time	
14	4x	BIN	16	1	Shooting power	
15	4x	BIN	16	1	Pieces of files downloaded to the controller	
16	4x	BIN	16	1	File number	
17	4x		64	4	File name (abcdefgh, 8 bytes shown in text mode)	
21~28	4x	BIN	16	1	Reserve	
29	4x	BIN	16	1	Processing time (h)	
30	4x	BIN	16	1	Processing time (m)	
31	4x	BIN	16	1	Processing time (s)	
32	4x	BIN	16	1	Working status	
33	4x	BIN	16	1	Download progress (with USB flash disk) (%)	

Please see following description on each bit (Address: 32)

F	E	D	C	B	A	9	8
							1: under jogging 0: stop jogging
7	6	5	4	3	2	1	0
1: start downloading 0: download completes	1: plug in USB flash disk 0: remove the USB flash disk	1: back to home 0: stop	1: back to home 0: stop	1: cut contour 0: finished	1: contouring 0: finished	1: start 0: stop	1: pause 0: resume

0x0002: under processing

0x0003: pause

0x0004: contouring

0x0008: cutting contour

0x0010: XY axes are restored

0x0020: Z axis is restored

0x0040: USB flash disk is detected

0x00c0: downloading data from USB flash disk

0x0080: download successful, remove the USB flash disk

0x0100: under jogging

Each value of the status register corresponding to specific status

6.3 Sample Program

Sample program (based on MT506LV45WV, BYD037L) is provided as reference for user's developing HMI.

Chapter 7 Download Document

For user's convenience, the firmware update file, processing file and configuration file can be downloaded conveniently using USB flash disk.

7.1 Update Firmware

- 1) Copy the updated firmware data (FM.FMW and 05LM201.HDW) to the root directory of USB flash disk (FAT16 format. Recommendation: do not save other files to the flash disk);
- 2) Electricify MPC6515, the indicate light D1 on MPC6515/CPU will flash twice swiftly;
- 3) Plug USB flash disk into MPC6515 within 5 seconds after D1 flashed twice;
- 4) If D1 keeps shining for 2-5 seconds (depending on the size of firmware update file), the firmware is being updated; If there's a indicate light in USB flash disk, user can tell if the data is being read through the indicate light;
- 5) D1 flashed swiftly, firmware is updated successfully; If there's a indicate light in USB flash disk, user can tell if the update is finished through the indicate light;
- 6) After removing the USB flash disk, DSP firmware program will be started.

If MPC6515 fails to work, it's probably that something's wrong during the update process.

Please repeat the above update steps or contact your supplier.

	User should update the firmware only when new version has been released.
Notice	

	To observe the updating process, it's recommended to use a USB flash disk with indicate light.
Notice	

7.2 Download Data

- 1) Copy the files (*.mol) created by engraving&cutting control software to the root directory of USB flash disk (FAT16 format).

Electrify the MPC6515

Plug the USB flash disk into the MPC6515;

If the indicate light D1 on the MPC6515/CPU keeps shining for seconds or minutes (depend on the file size), the controller is downloading processing file.

If D1 flashes swiftly, download completes;

Remove the USB flash disk, select and run the processing file through the control panel.

	Downloaded configuration file can only be effective after having been selected and run. Downloaded processing file can be started directly.
Notice	

	If you use MPC6515 for the first time, please create the configuration file according to the machine's parameters, and then download and run the file. Same operation should be followed each time the parameter's changes.
Notice	

	To observe the updating process, it's recommended to use a USB flash disk with indicate light. The user can also connect an external indicate signal (Refer to Hardware Interface).
Notice	

Chapter 8 Error Code

8.1 Indicator Light Description

Working status of MPC6515 can be shown through the 8 LED indicator lights on MC card and 4 indicator lights on CPU card. Please refer to Chapter4 to learn the position of indicator lights.

Indicator lights on CPU:

D1: indicate the working status of USB slave interface. It's normally flash green quickly;

D2: indicate the working status of USB slave interface. It's normally flash green slowly;

D3: indicate the operating status. It keeps shining green when processing graphics or downloading data from USB flash disk, and stops shining when the processing or downloading is stopped.

D4: No use

Indicator lights on MC:

D1: When MPC6515 powered on and started, D1 keeps shining;

D2: indicate pulse output status of Z axis. D2 keeps shining when Z axis is outputting pulses, and stops shining when outputting stopped.

D3: indicate pulse output status of Y axis. D3 keeps shining when Y axis is outputting pulses, and stops shining when outputting stopped.

D4: indicate pulse output status of X axis. D4 keeps shining when X axis is outputting pulses, and stops shining when outputting stopped.

D8: When CPU main loop of CPU board works normally, D8 flashes.

D7: When PAD03 is communicating with the MPC6515, D7 flashes.



8.2 Error Code Description

If there's any failure of the system, D1-D8 indicator lights on MC board indicate the error code. The coding rules are as follows:



D1 to D8 indicate an 8-bit status, and compose of 1-byte.



Example: when D8, D7 and D6 keep shining, and the other indicator lights are off, the error code should be 0xe0; when D1 to D4 are off, D5 to D8 are shining, the error code should be 0xf0.

Light status indicated by following symbols:

-  indicate the light is shining
-  indicate the light is off

Error codes descriptions are as follows:

Error Code	Lights Status(Left to right: D8 to D1)	Cause	Solution
0xe0		Process file or configuration file doesn't match with the firmware version.	Replace the function library with the correct one matching with the firmware version, and re-translate and download the process file and configuration file.
0xe1		Firmware doesn't match with MPC6515, such as the firmware of MPC05GA is used for MPC6515	Use the controller matched with the firmware
0xd0		Downloading data is too large, and exceeds the rest memory size of MPC6515	Delete all the downloaded files, and re-download the data
0xd2		Download error. Data transmitting error.	Re-download data.

0xd3		Data frames received through the serial port are too long; PAD03 failed to communicate with MPC6515	<ol style="list-style-type: none"> 1. restart MPC6515 2. if the error can't be eliminated by following the first step, replace PAD03 3. if the error can't be eliminated by following the second step, return for repair;
0xdf		Slave USB communicating overtime	<ol style="list-style-type: none"> 1. replace the USB communication cable 2. try on another PC if the error can't be eliminated by following the first step 3. return for repair if the error can't be eliminated by following the second step
0xf1		Configuration file error. User forgot to download configuration file or configuration file doesn't match with firmware	Re-download correct configuration file
		Downloaded firmware file (*.fmw) doesn't	Re-download matching firmware

0xf2		match with (*.hdw)firmware file	file
------	---	------------------------------------	------

	Please restart MPC6515 if there's any error to resume to normal status. Then resolve the problem according to the above error codes descriptions.
Caution	

D8

D1

Chapter 9 FAQ

9.1 External Indicator Light of U Disk

Functionality

User can't see the indicator lights on MPC6515 installed inside a machine. During the process of data downloading, user can observe the downloading process through the interface of PAD03, or through an external connected indicator light of the USB flash disk. The external indicator light is used to lead the reading status signal of USB flash disk to the machine panel, and show the status with LBD.

Instruction

Use Pin3 of Y1 on MPC6515/MC(Indicate light signal of USB flash disk) to drive the relay or LBD.

9.2 Customize PAD03 Control Panel

Functionality

PAD03 is composed of control panel, liquid crystal display and main board. If you want to customize the panel, please refer to the following interface description graph.

The control panel is connected to the main board through a 9pin header.

K1

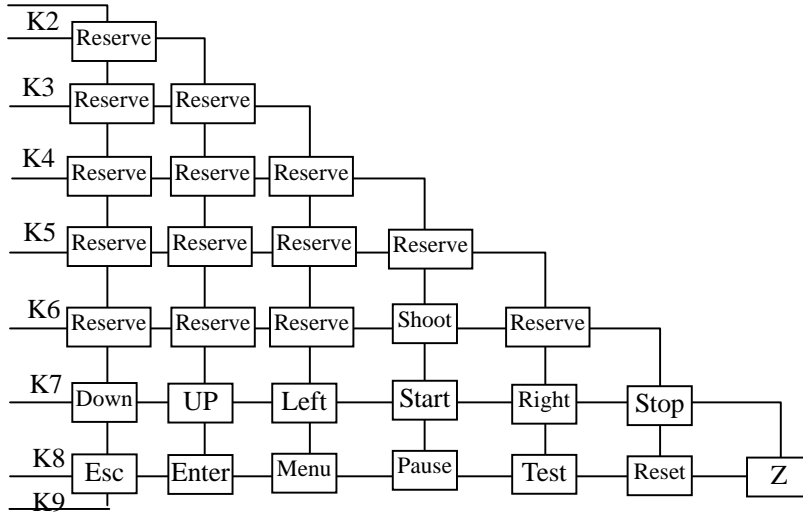

K9 connect to ground

User can design the panel according to the above diagram.

9.3 External Indicator Light of Processing Status

Functionality

To confirm the processing status before operating the system, an external indicator light could be connected to show the processing status. The external indicator light can be used to lead the processing status signals to the machine panel, and show the status with LBD or drive other indicator lights through circuit.

Instruction

Use Pin2 of Y1 on MPC6515/MC (light signal indicating process completion) to drive the relay or LBD.

9.4 Blow-off

Functionality

Blow-off switch can be controlled through I/O interface to blow off the heat and ash produced during the laser engraving and cutting.

Instruction

Pin1 of Y1 can be used as the I/O interface controlling blow-off. User can control the status of Pin1 using processing commands. When the interface is low level, blow-off is on.

When the interface is high level, blow-off is off.

9.5 Grade Engrave

Functionality

In accordance with the functionality of PCI-bus controller MPC03L*.

Instruction

The version of MPC6515 is required to be V4.1.0.0 or above. Version of software should be V2007.3.3 or above. Set the process mode as Grade Engrave on the software. MPC6515 V4.1.0.0 supports PWM grade engrave, and 1-ch analog grade engrave.

9.6 Software Limit under Immediate Mode

Functionality

This functionality is effective only on the premise that the machine has been to the origin point. Machine will auto-detect if the process exceed worktable before output.

Instruction

Upgrade the version of MPC6515 to V4.1.0.0 or above.

9.7 Control Two Laser Heads

Functionality

Control power of two laser heads independently.

Instruction

Upgrade MPC6515 to V4.1.0.0 or above. Upgrade software to V2007.3.3 or above. Set power mode to "LaserPowerMode=4", and set the distance of two laser heads.